



园区导览：富贵生命馆
Site Tour : Nirvana Center KL

Date : 03/02/2021 Time : 8pm Speaker : Camoon



富贵生命馆， 繁华都市中的生命殿堂

Nirvana Center KL, A Gem In The Bustling City

坐落在吉隆坡交通脉搏的黄金三角地带。

Located in Kuala Lumpur's vibrant Golden Triangle.

于2018年竣工并正式启用，为吉隆坡市中心独一无二五星级私营化骨灰殿堂。

Completed and opened in 2018, a unique private memorial hall in the heart of K.L.

整体建设结合休息大堂、办公室、骨灰殿、三圣殿、活动中心、停车场。

The complex consists of a reception lounge, offices, columbarium halls, main ceremonial temple, event spaces, underground parking bays.



目录

三圣殿 Temple of Three Saints

骨灰殿 Columbarium LV1 & LV2

追思礼堂 Memorial Parlour Hall

大堂接待处 Lobby Lounge



春节

三圣殿
Level 3A

记忆



三圣殿 Temple of Three Saints

三圣殿的设计取自中国无锡的梵宫，从而得到灵感而打造。
Inspiration from the Brahma Palace, Wuxi China.



三圣殿



生命馆的设计主要以高雅时尚的象牙白为主
NCKL design by elegant ivory white.



西方三圣

阿弥陀佛 Amitabha (中)
Infinite Merits, Infinite light,
Infinite Life

观世音菩萨 Guan shi yin (左)
Handheld *Jing Ping*,
Goddess of Mercy

大势至菩萨 Da shi zhi (右)
Handheld lotus, represents the
power of wisdom



地狱不空，誓不成佛，众生度尽，方证菩提
Dizang Wang vow not to achieve Buddhahood
until all hells are emptied.

地藏王



大殿左后方是大伯公，俗称土地公
Left rear side is Da Bo Gong, known as Tu Di Gong
or Fu De Zhen Shen.

福德正神





礼佛顺序 Sequence of Worship

西方三圣
Three Saints

地藏王
Di Zang Wang

大伯公
Da Bo Gong

- 
- ❖ 因为有空调，生命馆不可点香，只有后方大伯公可以点香。
 - ❖ **To maintain an overall great ambience in an otherwise air-conditioned setting, joss stick is prohibited except in DBG temple.**

三圣殿产品 Buddha Temple Products

01

神主牌

Ancestral
Tablet

02

升天仪式

Ascension
Ceremony

03

光明灯

Eternal
Blessing
Light

神主牌 Ancestral Tablet



供奉神主牌原因

Reason of consecrating Ancestral Tablet:

1

家属在海外发展，未能在家祭拜
Family members working overseas, not able to pay respect at home

2

外嫁女儿，不便在夫家供奉神主牌
Inconvenient for the married daughter to consecrate tablet at Husband's house

3

尽孝心
Fulfilling duty towards filial piety.

Section F

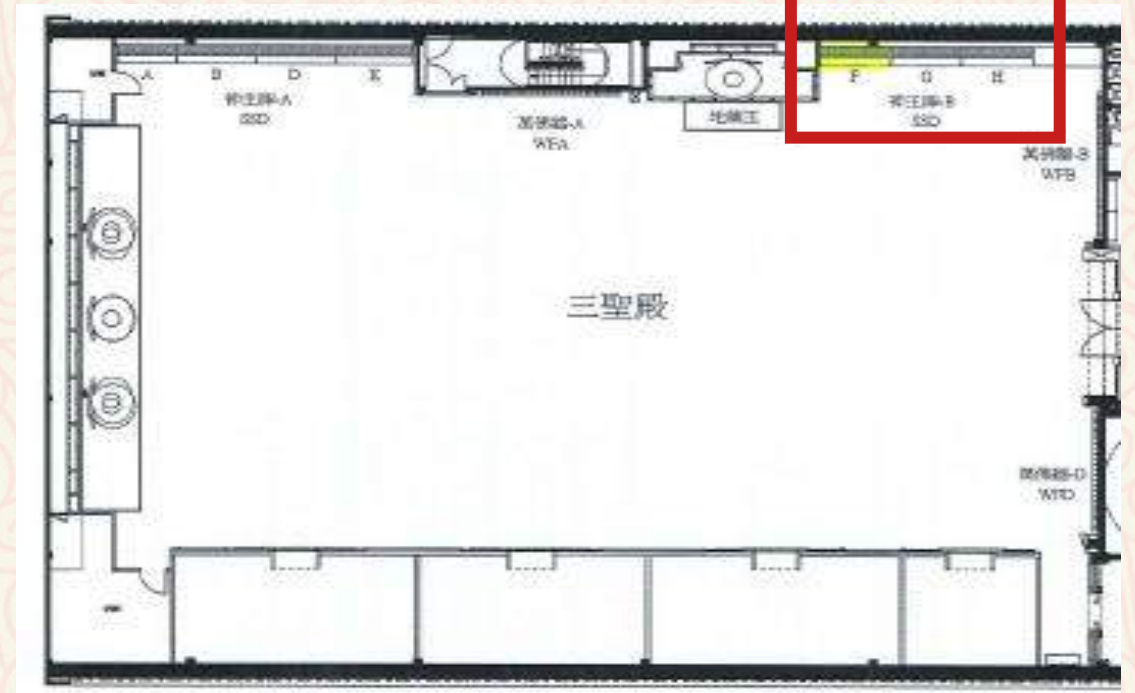
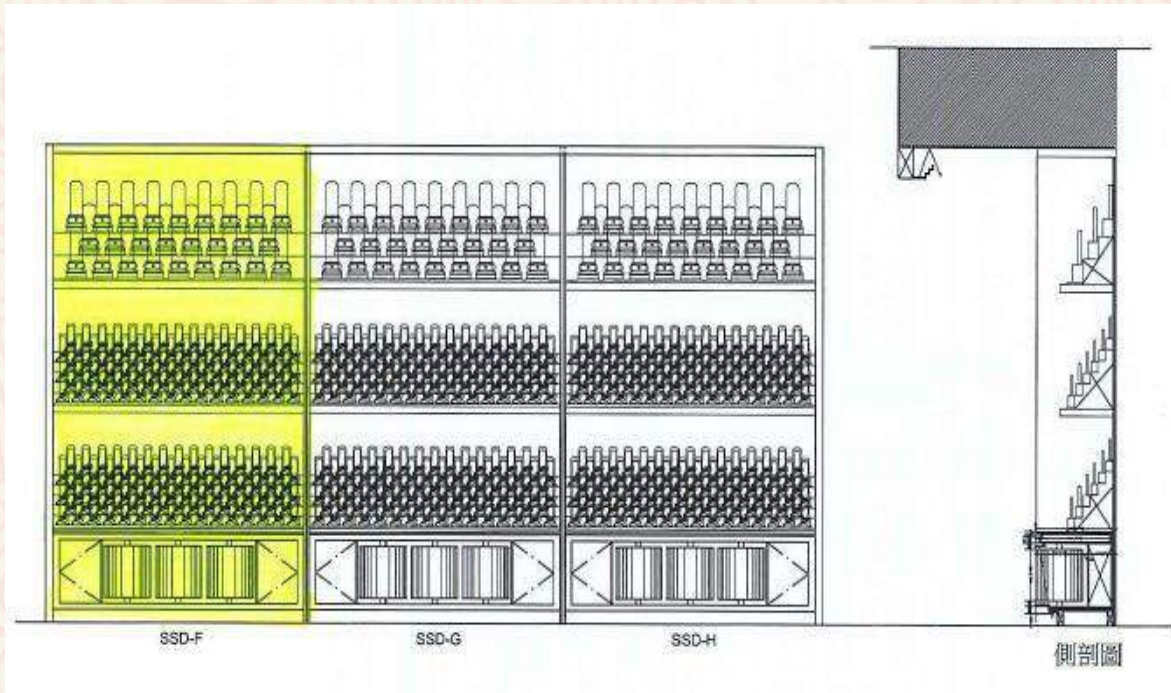

Section	Minimum Down Payment	Max. Instalment Tenure	Discount (Per Case)
F, G & H	20%	24 months	RM 1,500
	Full Payment	-	RM 3,000



升天仪式 Ascension Ceremony

目的是让家属在为往生者按位前做的殊胜仪式。以干冰特效及结合灯光造景和情景模拟，展示亡者往生极乐世界的仪式，意义让亡者安息，让生者安慰。



The Ascension Ceremony combines smoke effects and 3D mapping projection technology to create a divine experience. It brings thoughts of peace in sending the departed to world of bliss that transcends life and bring calm to the living.

Charges begin at 1/10/2020

~~RM1,088~~



RM388

万佛光明灯 Eternal Blessing Light



3 Designs:

阿弥陀佛光明灯
Amitabha Buddha

观音光明灯
Guanyin Pusa

蜡烛光明灯
Wishing Candle

- ❖ 光明灯也称“平安灯”，祈福保佑之用。
- ❖ Eternal Blessing Light means “Lamp of Well Wishes”, conferring blessing with protection and glory.
- ❖ 琉璃制造，琉璃有着净化的力量，被誉为佛教“七宝”之一。
- ❖ Crystal glass represents the power of purification and known as one of the “7 Treasures” of Chinese Buddhism.

万佛光明灯 Eternal Blessing Light

WANFO Section D

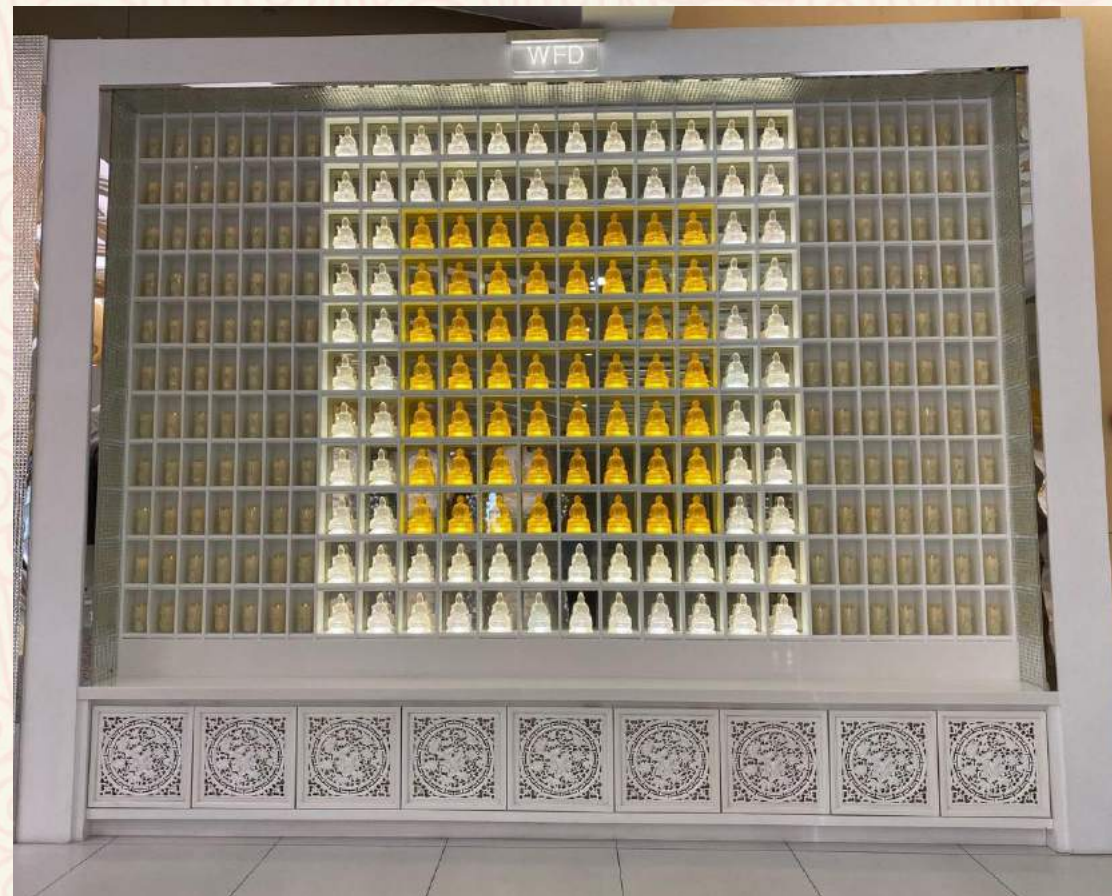
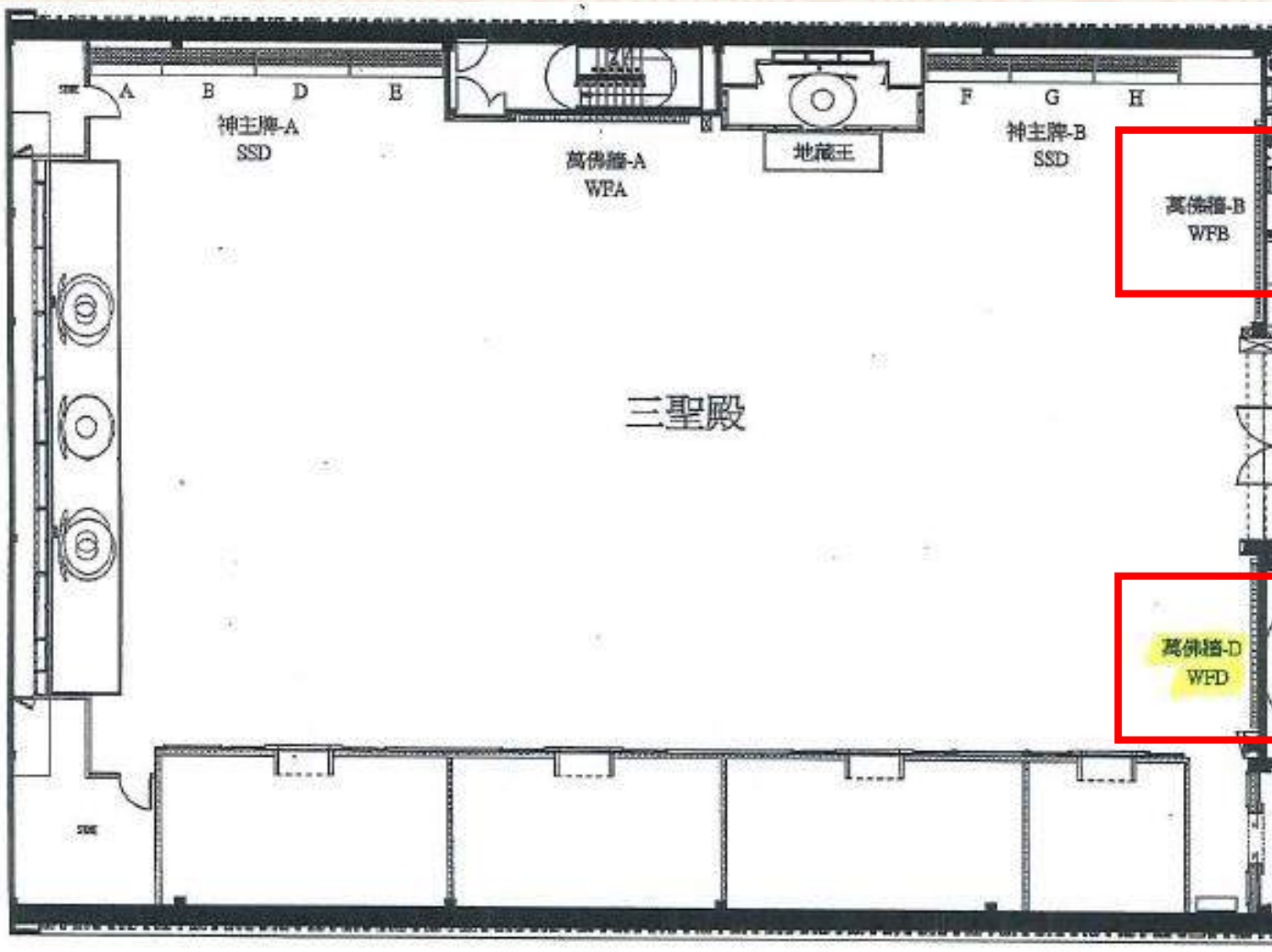

WANFO - B

Section	Level	Payment Mode	Original Price	Promotion Price
WFB	AB	Full Payment	RM 2,388	RM 1,888
	GB		RM 1,988	RM 1,488
	CB		RM 1,688	RM 1,088

WANFO - D

Section	Level	Payment Mode	Original Price	Promotion Price
WFD	AD	Full Payment	RM 2,588	RM 1,988
	GD		RM 2,188	RM 1,588
	CD		RM 1,688	RM 1,088

**The Package is valid for 12 months*

**Promotion period: 01/01/2021 – 28/02/2021*



春节

骨灰殿
Level 1 & 2

记忆





1st Floor / 一樓



Mesanine Floor - Memorial Halls 追思禮堂
Ground Floor - Lobby & Other Facilities 大廳及其它設施

HALL A



HALL B



HALL D



价格
Price

设计
Design

信仰
Religion

客制
Customized

牛年大发





-10%

10% down payment

-20%

20% & above down payment

-30%

FULL payment

01

Promotion

- * Any purchases of burial plots or niches
- * Promotion date: 01/01/2021 – 28/02/2021



Cash rebates worth up to
RM100,000

Nirvana Chinese New Year promotions are here!

With every purchase of Nirvana pre-need products

(niche, burial plot, NV Seed, ancestral tablet &

Nirvana Life Plan) worth RM10,000 or above, enjoy the opportunity to participate in

the Ang Pow Lucky Draw and win cash rebates worth up to RM100,000

You don't want to miss this!

* The Ang Pow Lucky Draw is only available at Nirvana Memorial Center,
 Nirvana Center Kuala Lumpur, Nirvana Memorial Park (Semenyih),
 Nirvana Memorial Park (Shah Alam) and Nirvana Memorial Park (Ipoh)

* Terms & Conditions Apply



For more information, please contact our authorized agents

02

Lucky Draw

Product	Nett Main Product Price (Per PO)	Angpow Dip (Per PO)
Burial Plot, Niche, NLP, NV Seed, AT	≥ RM 10,000	RM 88
		RM 188
		RM 288

* Promotion date: 01/02/2021 – 28/02/2021

03 Gift

NIRVANA PURCHASE GIVEAWAYS

Due to overwhelming response promotion is extended until 28.02.2021

Gifting during the festive season not only brings joy to family and friends, it also shows how much we appreciate and care for them.

In conjunction with the coming Year of the Ox, Nirvana is bringing to you two special offers in celebration of the New Year so that you can purchase our products while sharing gifts of auspicious greetings with loved ones.

Offer 1
With any purchase of plots or niches worth RM20,000 or above, receive an extravagant and beautifully wrapped, Eu Yan Sang *Ayasa Prosperity* gift hamper absolutely free!

Offer 2
With any purchase of plots or niches worth RM50,000 or above, receive an exquisite and magnificently wrapped, Eu Yan Sang *Growing Fortune* gift hamper absolutely free and bring joy to loved ones!

Eu Yan Sang Ayasa Prosperity gift hamper

Eu Yan Sang Growing Fortune gift hamper

Limited stock, first come first served!

By promotion is only available for Nirvana Centre (Main, Lamer and Terminal) branch only. (Please refer to the branch list) and subject to be delivered to you by the customer support team as subject to change.

For more information, please contact our staff/branch agents.

Product	Nett Main Product Price (Per PO)	Special Gift
Burial Plot, Niche	≥ RM 20,000	1 set of Eu Yan Sang CNY Hamper (A) <i>(Limited to 50 set)</i>
	≥ RM 50,000	1 set of Eu Yan Sang CNY Hamper (B) <i>(Limited to 10 set)</i>

* Promotion date: 01/01/2021 – 28/02/2021



Level /
HALL A



Hall A : A1-S1

Hall A has 12 rooms in total.

A1-S1 is the most beautiful suite in Hall A.

Similar with A1-S10



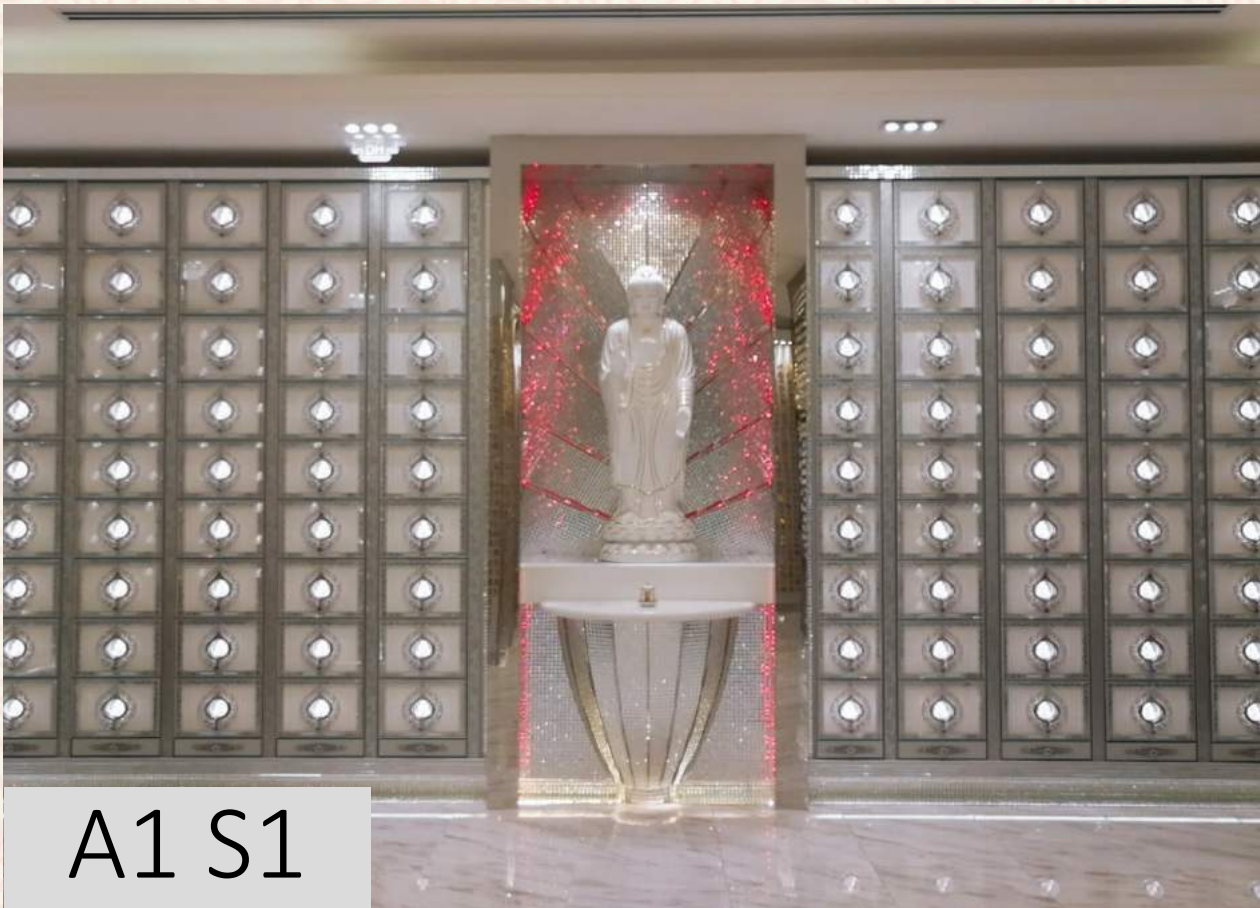

A1 S1

Double : RM 33,800 - RM 55,800

Single : RM 16,800 - RM 26,800

* Price not include maintenance fees RM5,000(D) / RM2,500(S)

Total Lot	Available Lot	%
783	119	15.20



A1 S10

Double : RM 50,800 - RM 68,800

Single : RM 25,800 - RM 34,800

* Price not include maintenance fees RM5,000(D) / RM2,500(S)

Total Lot	Available Lot	%
609	426	69.95

伴佛位

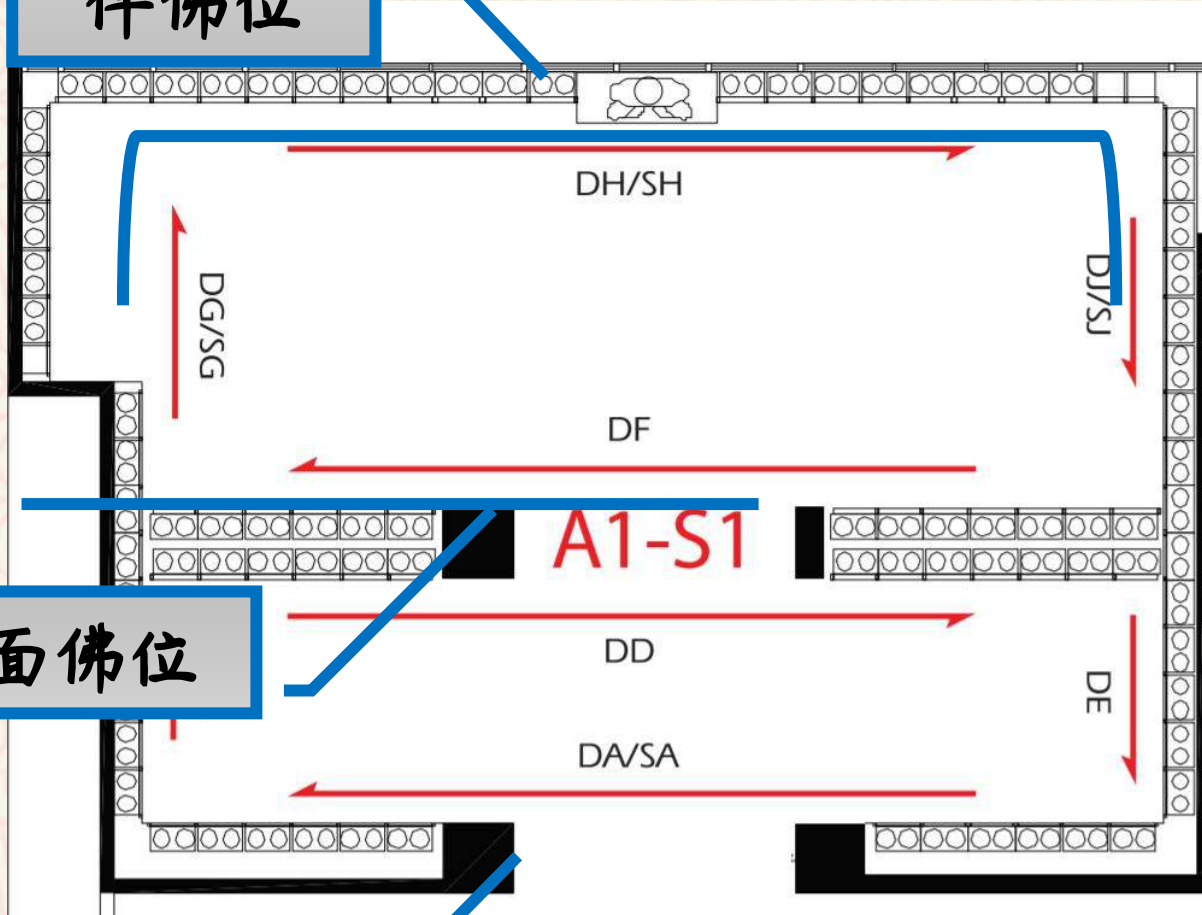

面佛位

随佛位

Small
08

Big
208

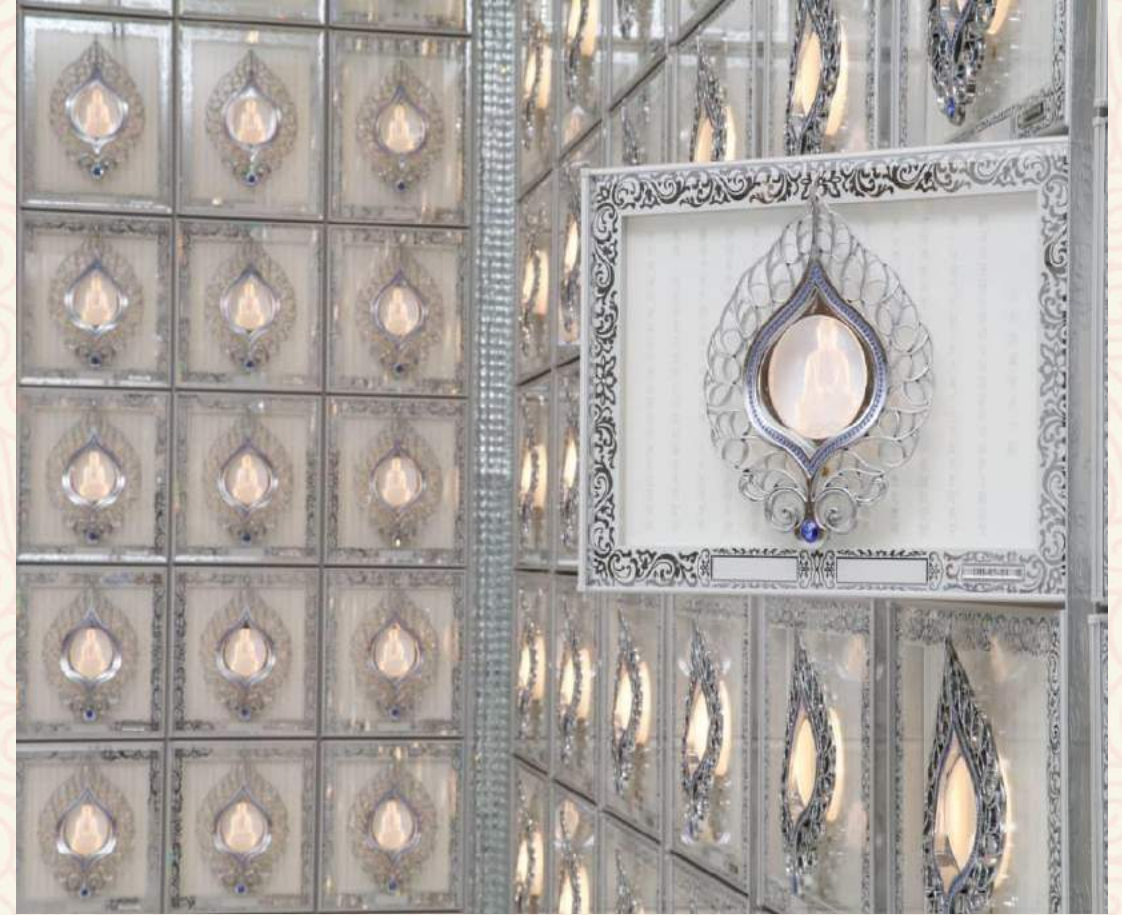

骨灰门板从“左”开到“右”
Door panel open from left to right.

Hall A : A1-S8 Free Thinker 自由信仰者



Double : RM 38,800 - RM 56,800
Single : RM 19,800 - RM 27,800
Family : RM 74,800

* Price not include maintenance fees RM5,000(D) / RM2,500(S) / RM8,000(F)

Hall A : A1-S8 Free Thinker 自由信仰者

第一间不是以佛像为门板设计的房间，
因适应市场变迁以及自由信仰者的趋势
To adapt the market changes and the trend of
free thinker, A1-S8 niche panel not designed
with Buddha status.

家庭式骨灰位

Duplex Niche, able to put 4 niches.

以“莲花”为门板设计

Use lotus flower as niche panel design.



外



内

Hall A : A1-S8 **Free Thinker** 自由信仰者



宗教/无神论者都适用

Applicable for religious/free thinker

佛、道、基督、天主、印度、日本教



莲花代表品格高尚，出淤泥而不染

Lotus flower is a symbol of beauty, purity, nobility...

花语：美丽、爱、高尚、清白、坚贞、纯洁



莲花也代表爱情。莲花是百花之中花（身）、果（心）、种子（灵）并存的植物

Lotus symbolize the lingering love between lovers.

夫妻同心、爱情长存

Total Lot	Available Lot	%
402	55	13.68

Hall A : A1-S11 & S12 Free Thinker 自由信仰者



A1-S11

Total Lot	Available Lot	%
340	218	64.17

A1-S12

Total Lot	Available Lot	%
316	190	60.12



Hall A : A1-S11



Hall A : A1-S12



Double : RM 38,800 - RM 51,800

Single : RM 19,800 - RM 27,800

Family : RM74,800

* Price not include maintenance fees RM5,000(D) / RM2,500(S) / RM8,000(F)

Hall A : A1-S11 & S12

Free Thinker 自由信仰者

❖A1-S11 以“牡丹花”为主 Peony Flower

- 深得女士/贵妇喜爱 Lady's favorite flower
- 百花之王，地位尊贵 King of flowers
- 代表富贵，幸福，繁荣 Prosperity, good fortune



牡丹之贵
S11

❖A1-S12 以“莲花”为主 Lotus Flower



莲花之华
S12

S11



S12





A1 S11 Family Lot



A1 S12 Family Lot

Hall A : A1-S9 Christian 基督徒骨灰殿



Hall A : A1-S9 Christian 基督徒骨灰殿

Hall A **唯一** 一间基督与天主教的骨灰殿堂。
The only Christian & Catholic suite in Hall A.

门板设计新颖、和谐，符合基督天主教徒喜爱纯洁无瑕的元素。
The purity elements and modern design suitable for Christian & Catholic.

家属可以在恬静典雅及舒适的环境中缅怀亲人。
Family members can pay homage to their ancestors at a serene and relaxed environment.

Double : RM 39,800 - RM 51,800

Single : RM 19,800 - RM 26,800

* Price not include maintenance fees RM5,000(D) / RM2,500(S)

Total Lot	Available Lot	%
288	123	42.70



门板外侧设计



门板内侧设计



Level /
HALL B



Christian Suite

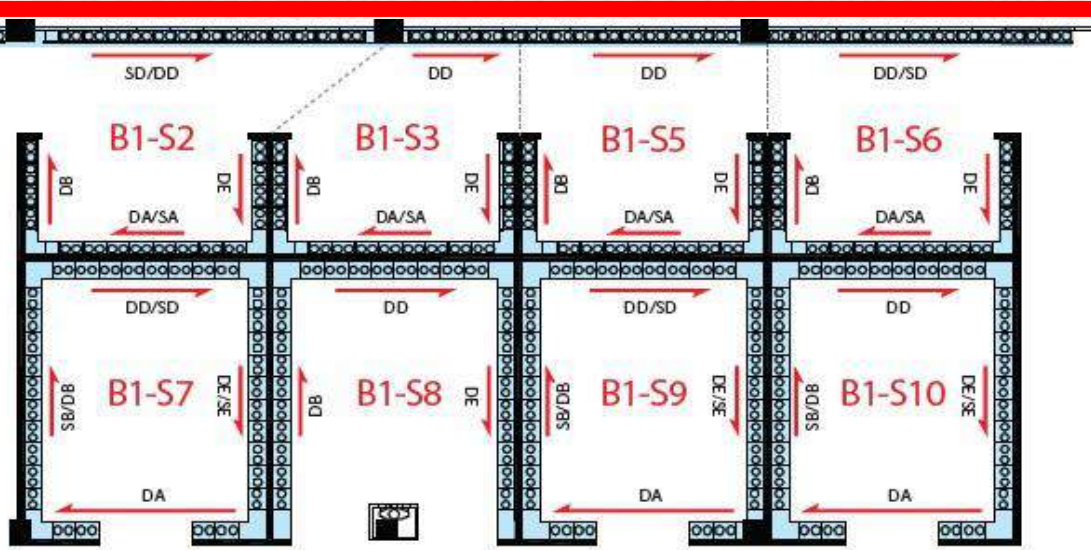
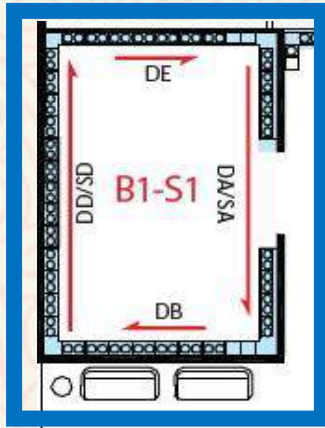

Buddha / Tao Suite

Free Thinking Suite

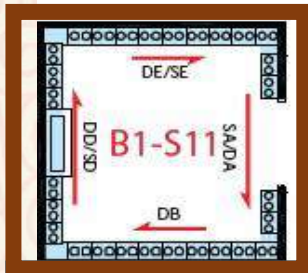

Christian Suite

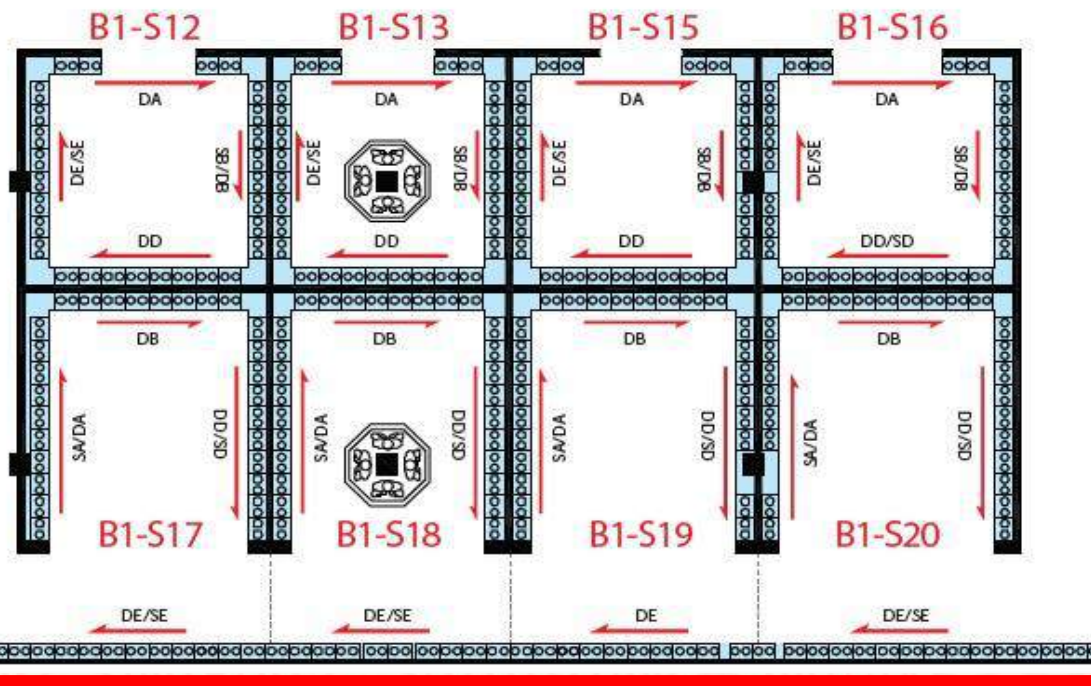
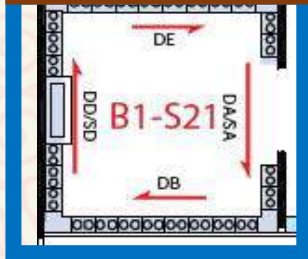

门板设计以 佛祖为主



古典宫廷式的设计

HALL B1

50% OFF

Block	Lot Type	Min. Down Payment	Max. Monthly Instalment
B1 (Section DE/SE S8,17,18,19,20)	Double	20%	48
	Single		36
B1 – Level 1,2,8,9	Double		48
	Single		36

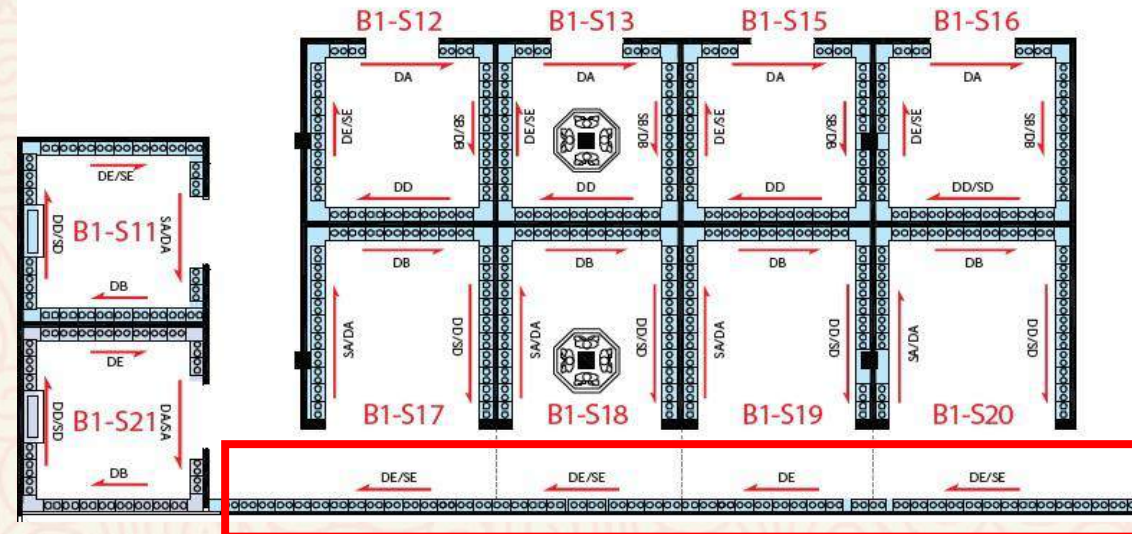
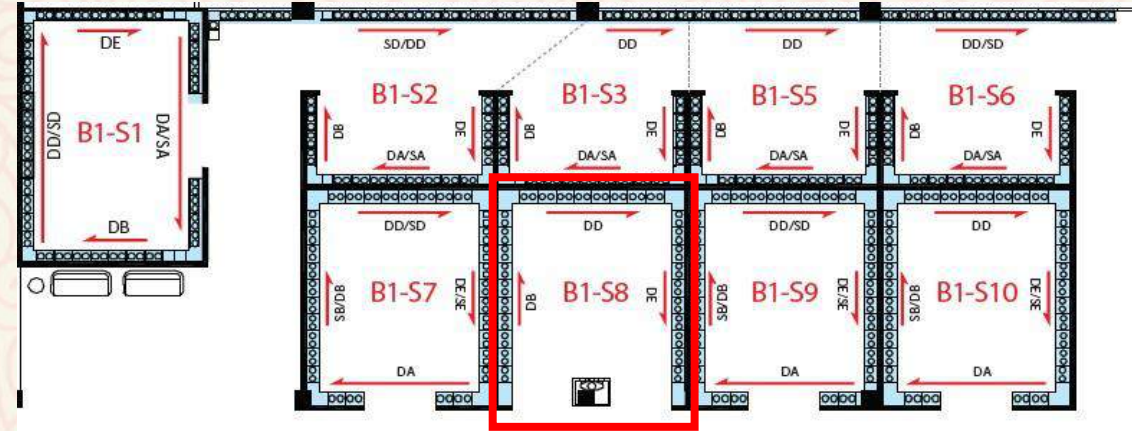

HALL B : B1-S17 – S20 (DE/SE)

50% OFF

DOUBLE (level 1) :

RM 27,800 – RM 13,900 (50 %) + RM 5,000 (maintenance) = RM 18,900

SINGLE (level 1) :

RM 13,800 – RM 6,900 (50 %) + RM 2,500 (maintenance) = RM 9,400

DOUBLE (eye level) :

RM 38,800 – RM 19,400 (50 %) + RM 5,000 (maintenance) = RM 24,400

SINGLE (eye level) :

RM 19,800 – RM 9,900 (50 %) + RM 2,500 (maintenance) = RM 12,400



Level /
HALL D





Hall D 具有开放式的环境
Open air environment

有播放佛曲
Buddhist music surrounding the hall.

设备齐全，空间宽敞
Spacious and cosy space.

-10%

10% down payment

-20%

20% & above down payment

-30%

FULL payment

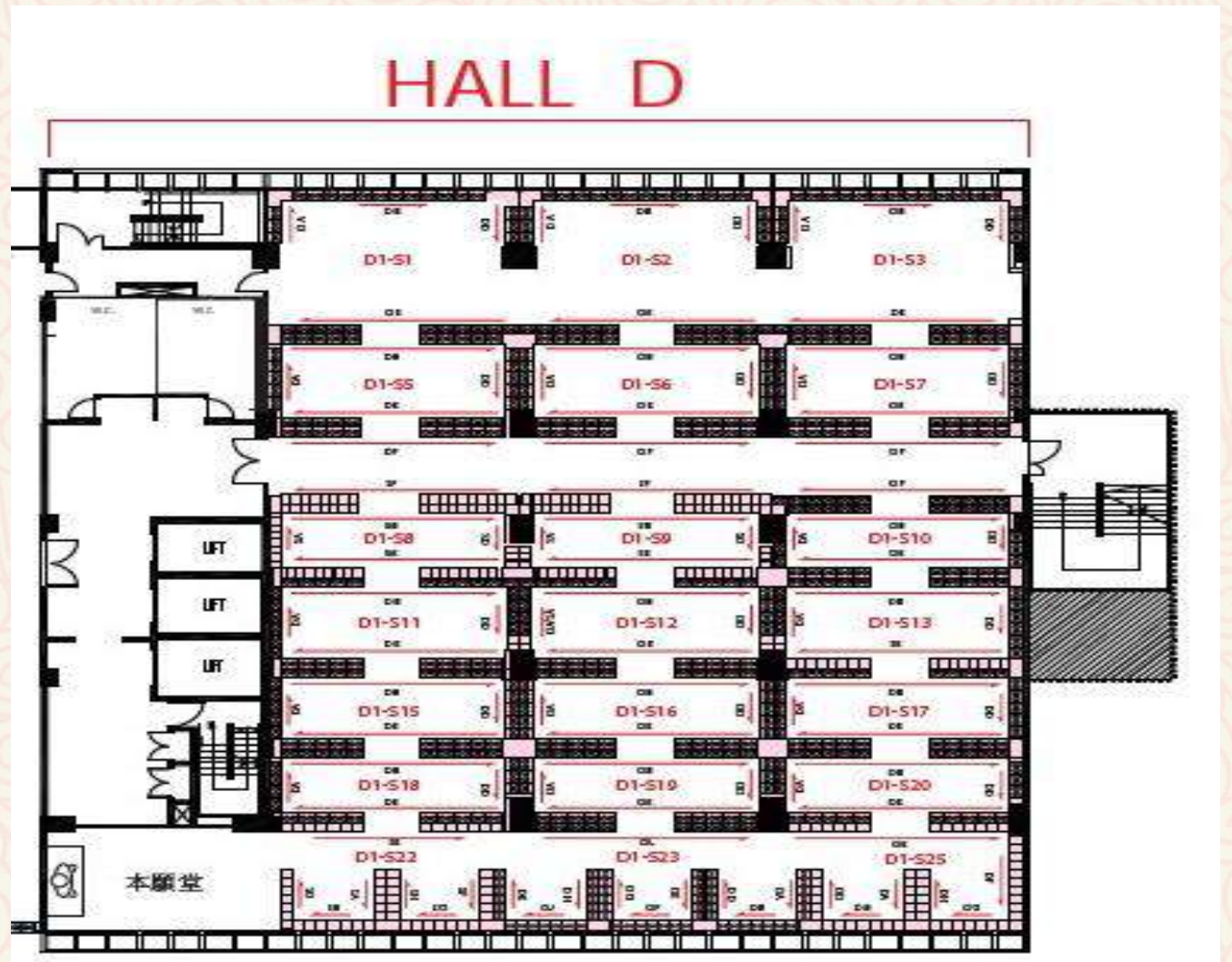

Product	Max. Monthly Instalment
D1 – D25	24 Months

- L9
- L8
- L7
- L6
- L5
- L3A
- L3
- L2
- L1

Penthouse
 Big space (大骨灰瓮),
 Relocation (拾金), 较难被人开到

Eye level, 依据身高

孝子位, 放花 (tray),
 L3 children eye level,
 Sitting eye level



A1-S1
 Eye level : RM54,800
 Level 1 : RM33,800
 Level 2 : RM38,800

SAVE 节省
RM 16,000 – RM 21,000

Pre-Need FSP Customer Promotion with Installment Tenure

Type of Package	Original Price	Special Discount	Net Package Price
NV Honour	RM 32,780	RM 1,980	RM 30,800
NV Elegant	RM 25,480	RM 1,480	RM 24,000
NV Harmony	RM 17,180	RM 1,080	RM 16,100
NV Gracious	RM 16,280	RM 980	RM 15,300
NV Blessing	RM 12,780	-	RM 12,780

* Promotion date: 01/01/2021 – 28/02/2021

* Special Discount uom RM6k & RM4k down payment.



NV ELEGANT Plus (升級版) 富貴安祥 (升級版) RM 28,800

An enhanced comprehensive and luxurious package for a complete and dignified celebration of life.

一個更全面、完善及高尚的殯儀配套，
為您獻上莊嚴及圓滿的生命禮讚。







富贵生命馆 吉隆坡
NIRVANA CENTER KL

JALAN DEWAN BAHASA

A2-S1

生命長廊

之

藏恩閣

—— 骨灰殿 ——

經典珍藏 留住記憶

Suite A2-S1





为先人打造永恒的住所， 典藏人生故事的记忆

✘ 千万不要把它称为图书馆
✘ 书 ，因为输输声

✔ 骨灰阁 - 文昌阁
✔ 骨灰位 - 文昌位
✔ 书称为册 - 生命册



用处
是什么?



1) 文昌阁/文昌位

望子成龙，望女成鳳是每个家长的心愿。

2) 生命纪念册

册字的写法像什么？

像古代竹筒，中间用绳子串起来，记录重要事情。

代表传承，一代传一代

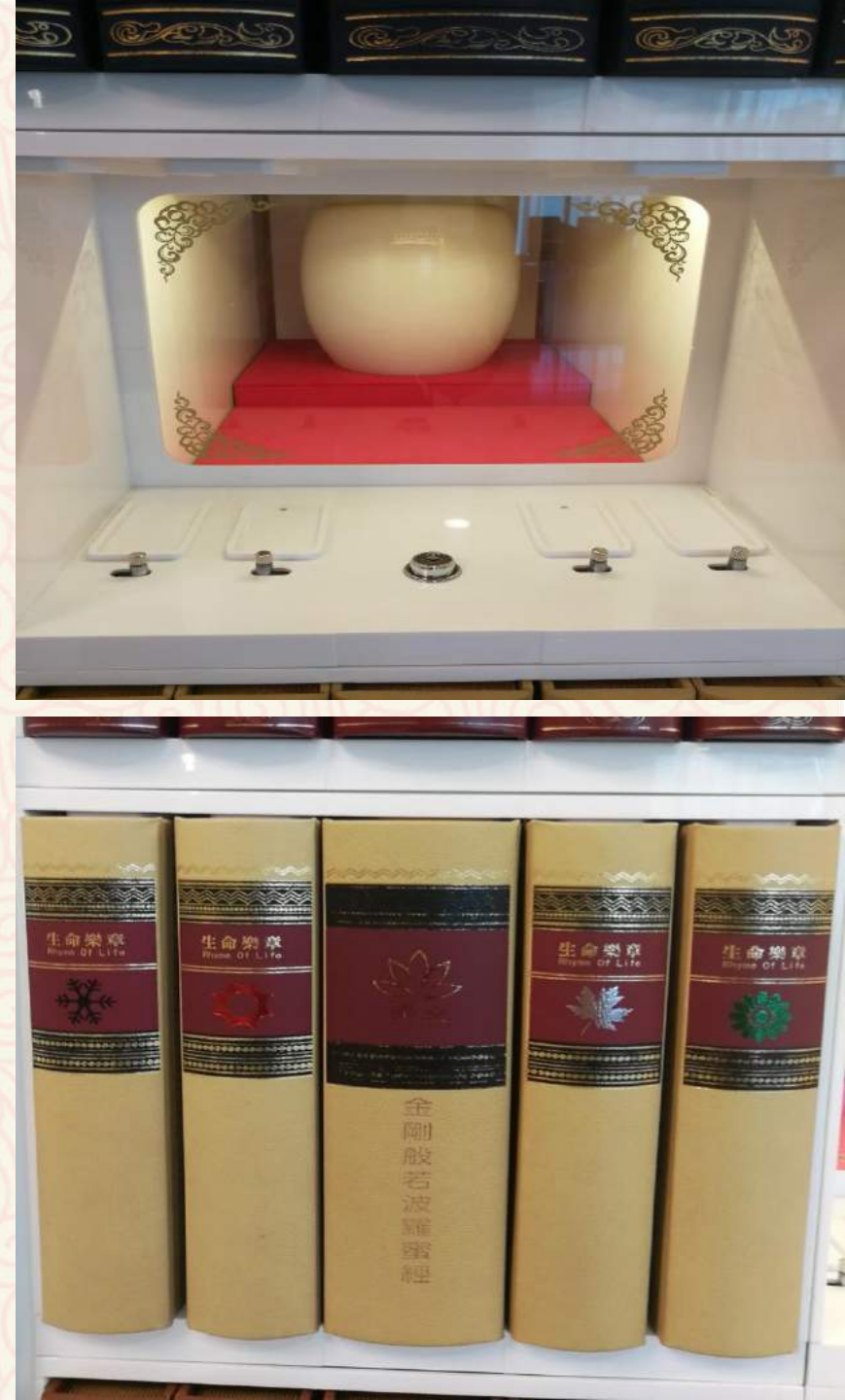

具纪念价值的物品：

一份纪念

一份传承

照片

日记本

徽章/证书

族谱

家训

自传

纪念物品

信件/卡片

对后代的叮咛&祝福

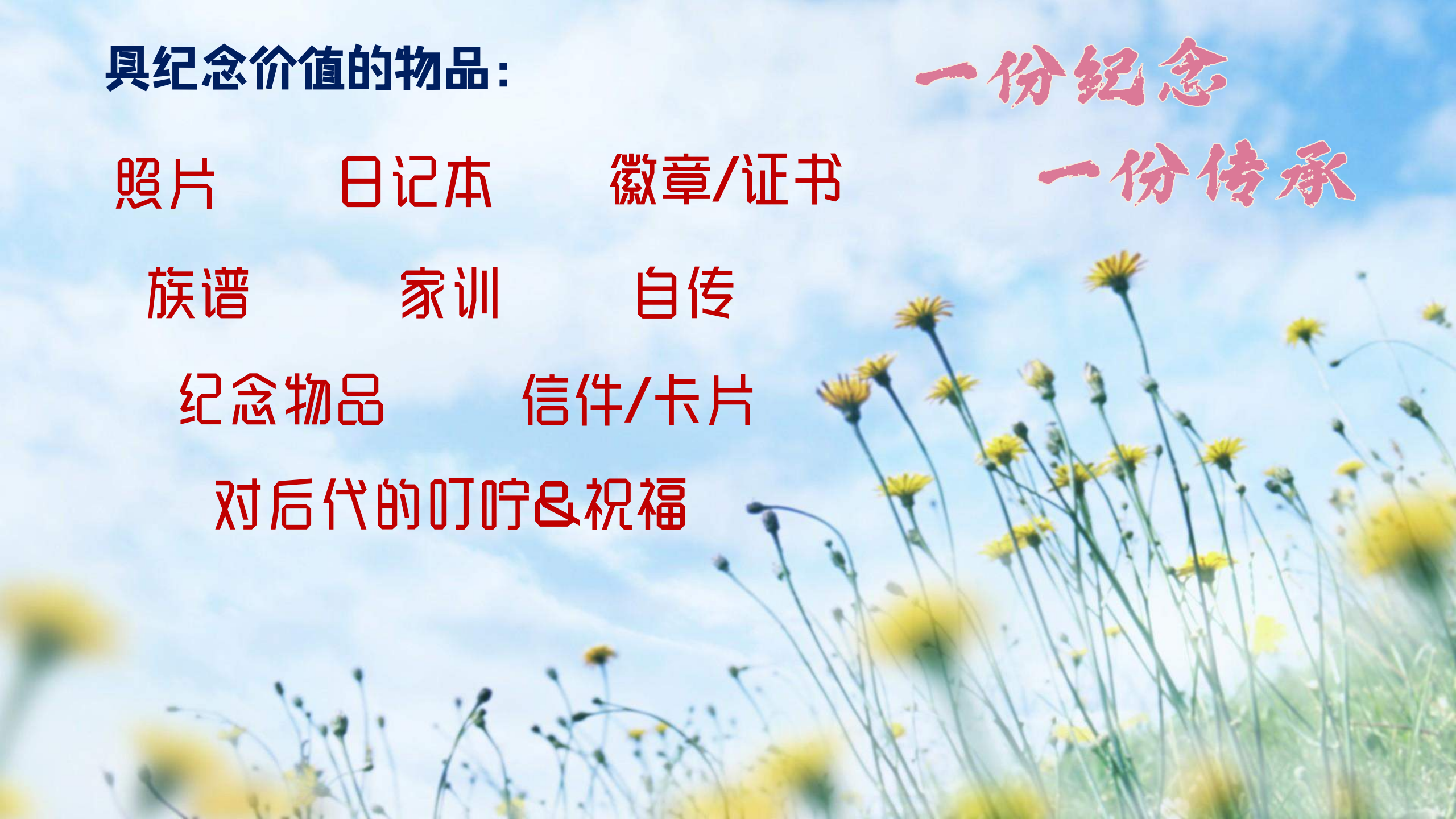

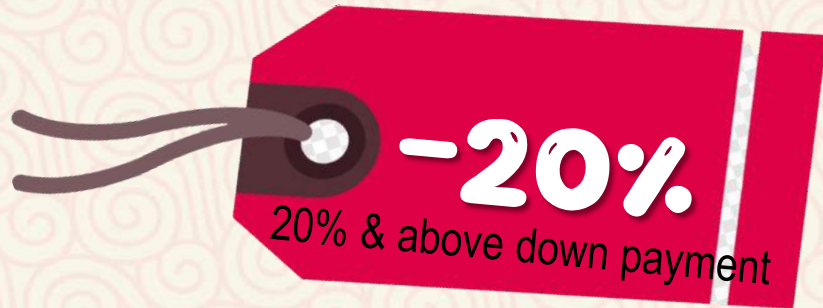

DH (Eye Level):

10% : RM 68,800 - RM 6,880 = RM 61,920

20% : RM 68,800 - RM 13,760 = RM 55,040

30% : RM 68,800 - RM 20,640 = RM 48,160

* Price not include maintenance fees RM3,000



FJ (Eye Level):

10% : RM 108,800 - RM 10,880 = RM 97,920

20% : RM 108,800 - RM 21,760 = RM 87,040

30% : RM 108,800 - RM 32,640 = RM 76,160

* Price not include maintenance fees RM6,000



DK & DH : RM 53,800 - RM 68,800
FJ, FL, FG : RM 78,800 - RM 108,800
* Price not include maintenance fees RM3,000(D) / RM6,000(F)

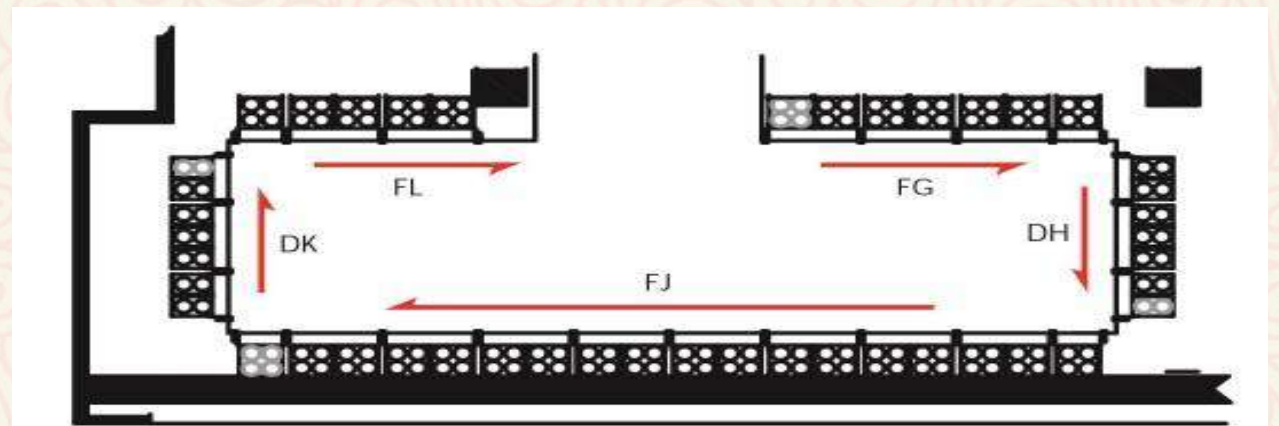

Family Suite Level 2 : A2-S5



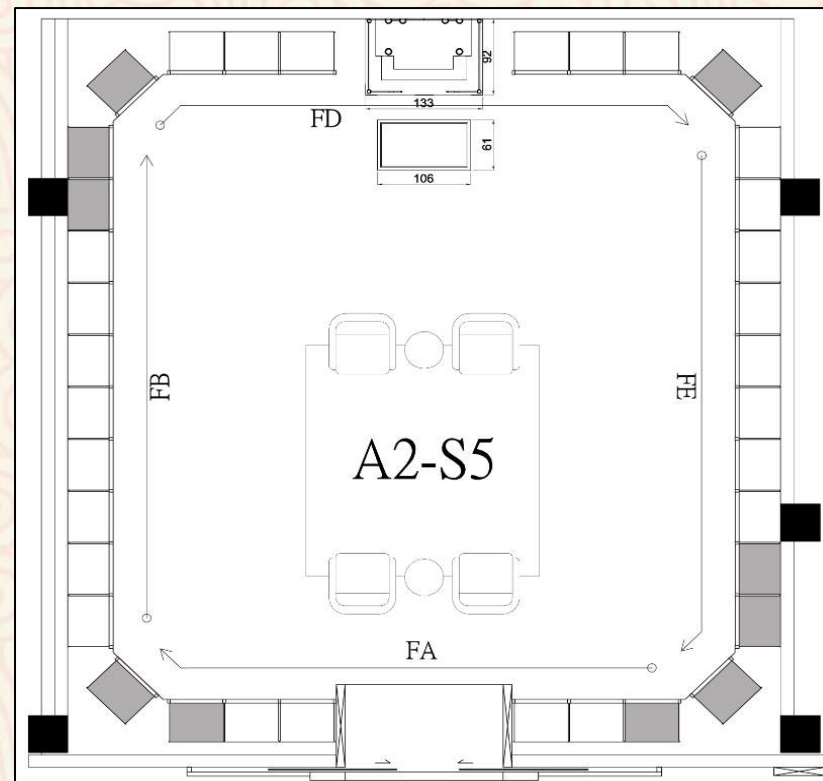
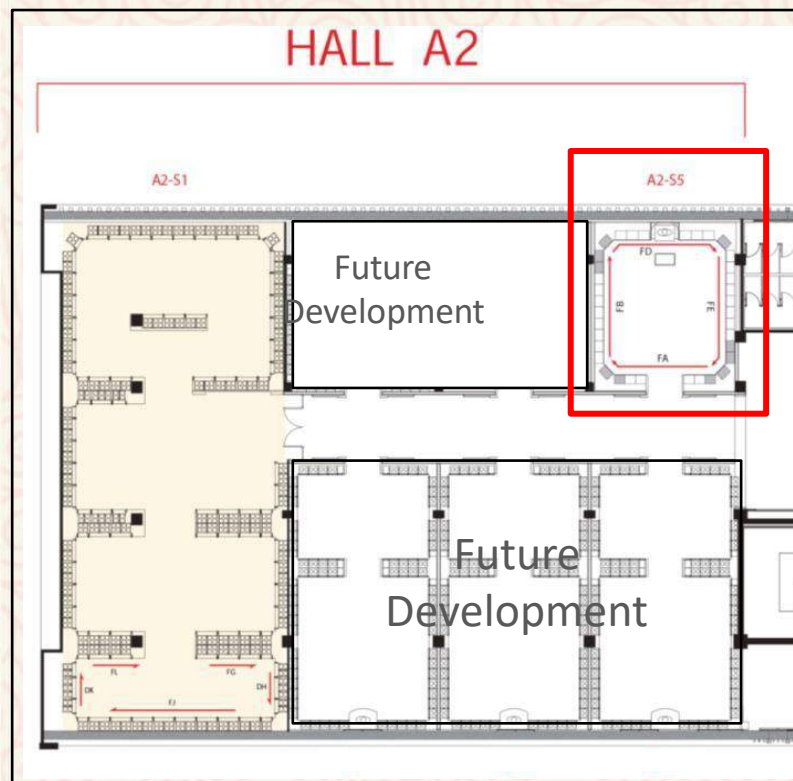

Super Low Density
超低密度

Only 36 units in total
一共只有36柱

A2-S5 Features 特点

4 levels of double niches

Max urn storage capacity of 16 units

4层双位，可存放到达16个骨灰瓮

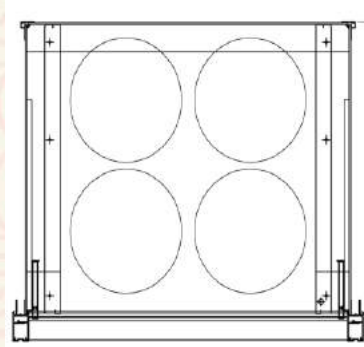

1 Big ancestral tablet

8 small ancestral tablets

1个大神主牌，8个小神主牌



Private pull out praying table

独立抽屉式祭拜枱

Customized family name on the unit

家族姓氏个性化命名



FA & FD

RM328,000

FB & FE

RM298,000

Maintenance Fee 维修费:
每柱 RM20,000 per unit

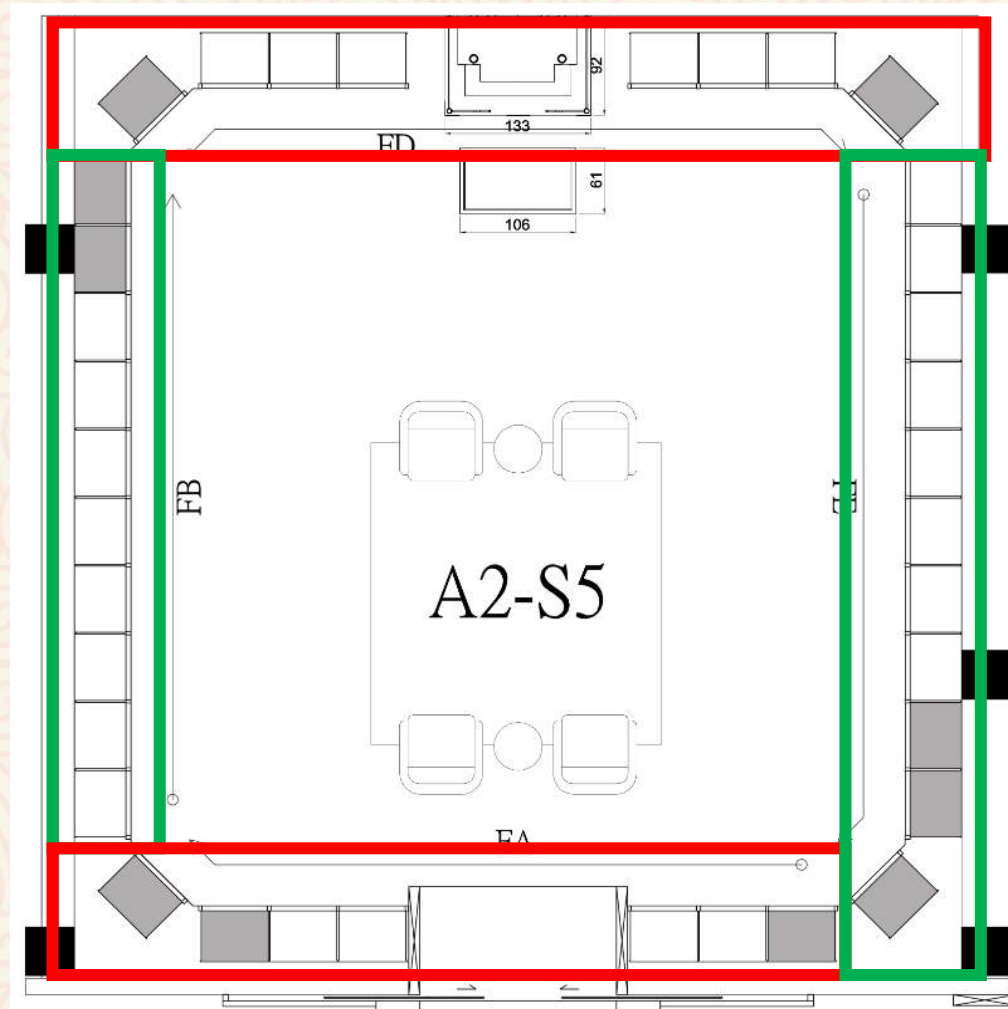



A2-S5 (FA)

10% : RM 328,000 - RM 32,800 = RM 295,200

20% : RM 328,000 - RM 65,600 = RM 262,400

30% : RM 328,000 - RM 98,400 = RM 229,600





Level 2
HALL B



Buddha/Tao Suite B2-S3 & B2-S5

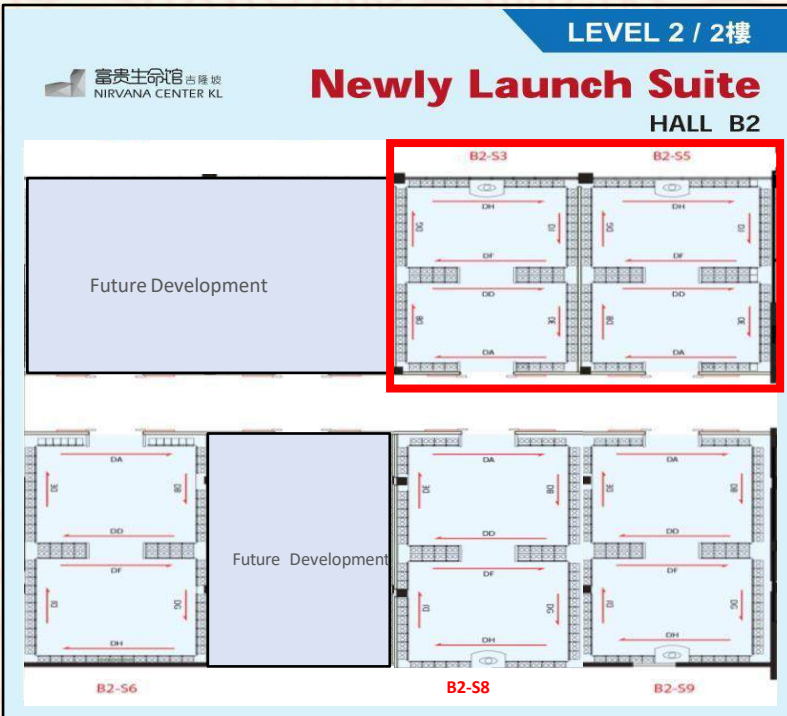

Ready for interment :10 June 2020

-10%
10% down payment

-20%
20% & above down payment

-30%
FULL payment

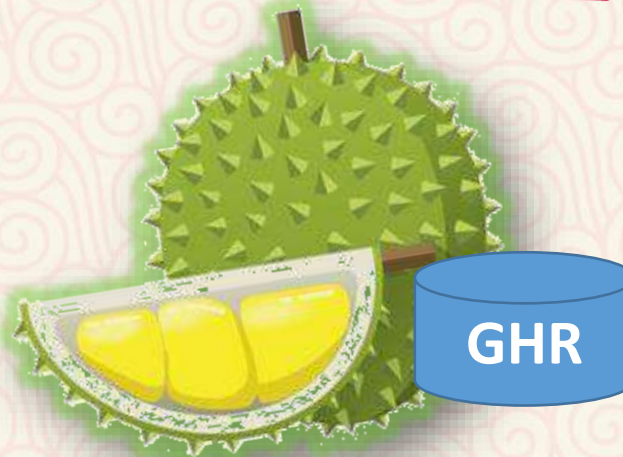

Suite B2-S3 & B2-S5



Double : RM 38,800 - RM 57,800

Single : RM 20,800 - RM 28,800

* Price not include maintenance fees RM5,000(D) / RM2,500(S)

	Total Lot	Available Lot	%
B2-S3	636	196	30.81
B2-S5	672	189	28.12

Level 2 : B2-S6 Christian & Catholic Suite

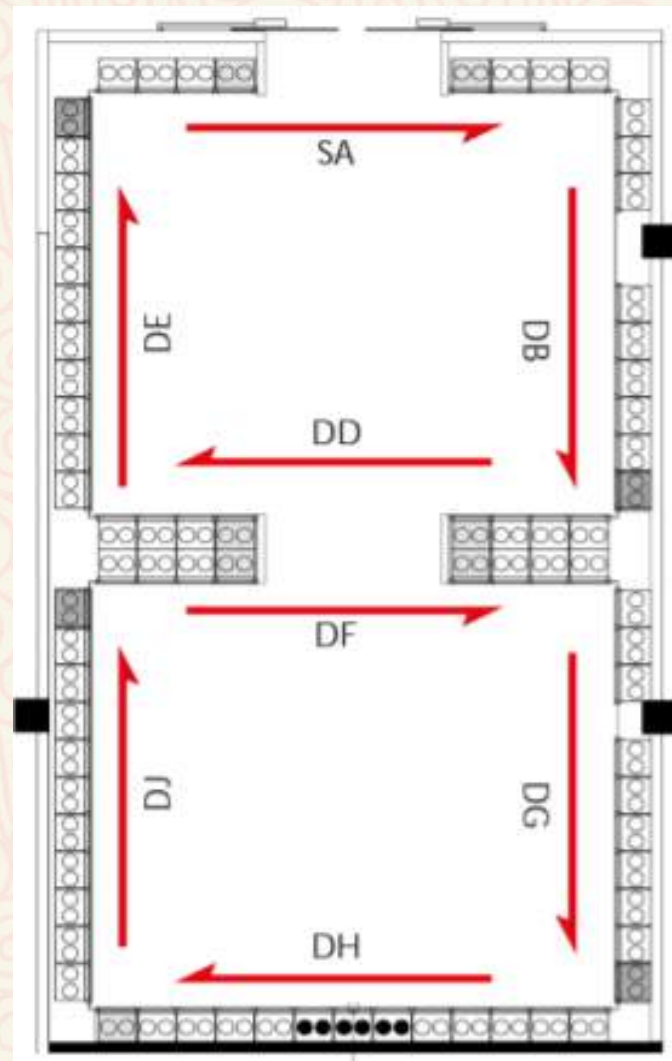
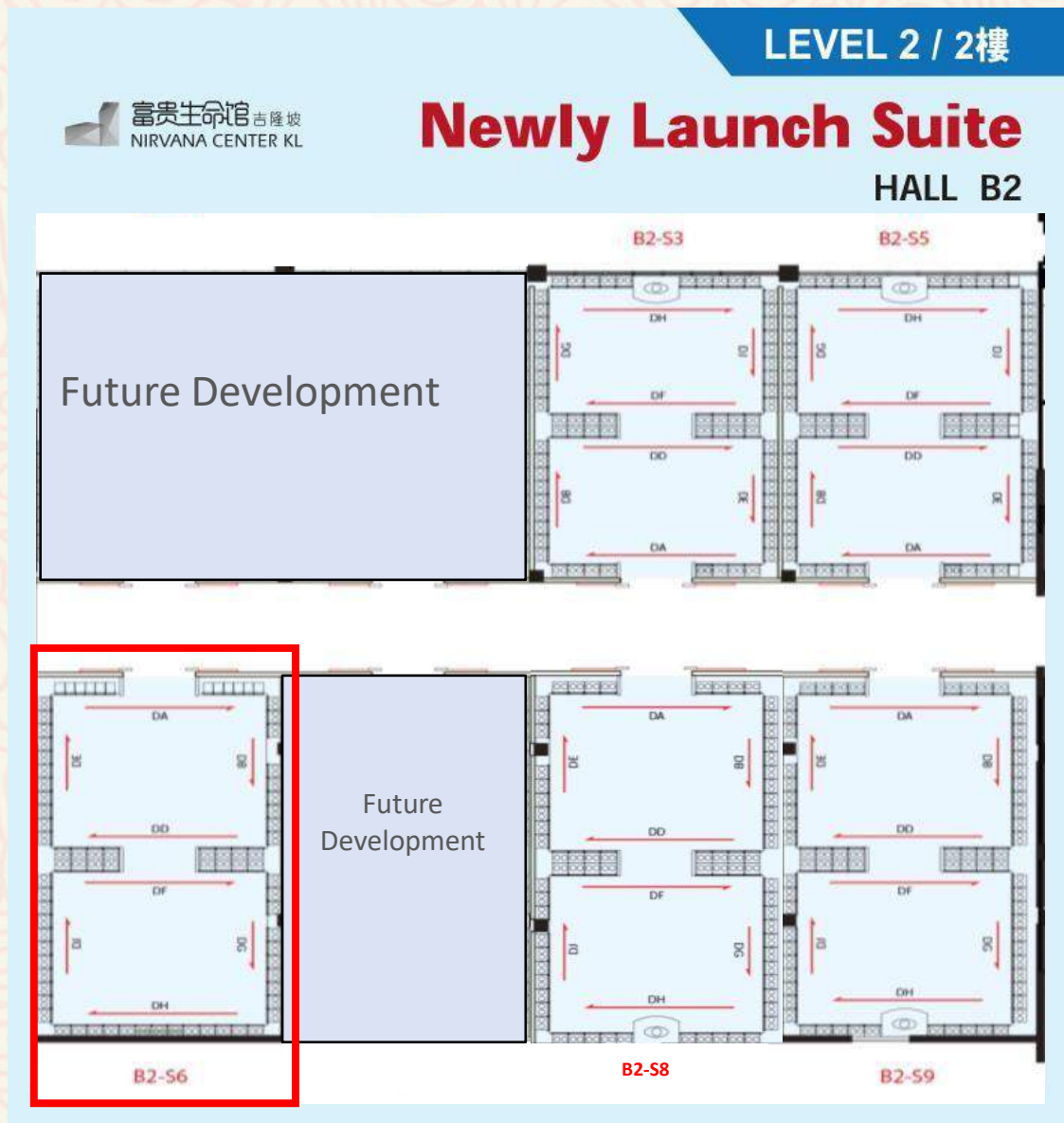

Suite B2-S6



Double : RM 35,800 - RM 54,800

Single : RM 19,800 - RM 27,800

* Price not include maintenance fees RM5,000(D) / RM2,500(S)

Total Lot	Available Lot	%
612	310	50.65

Double:

51(W) x 30(H) x 40(D)

51(W) x 36(H) x 40(D)

Single:

32(W) x 30(H) x 40(D)

32(W) x 36(H) x 40(D)



B2-S6 (Eye level / Double)

10% : RM 54,800 - RM 5,480 = RM 49,320

20% : RM 54,800 - RM 10,960 = RM 43,840

30% : RM 54,800 - RM 16,440 = RM 38,360

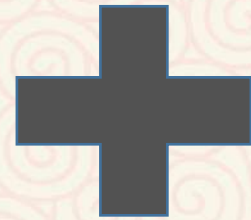

全新推介
 限時限量

富貴生命館 吉隆坡
 NIRVANA CENTER KL

Hall B2-S8

法輪
 門板設計骨灰閣



法輪常轉，藉由法輪把一切厄運帶走，故能祈願消災，消除業障。

突破一般塔位門板的思維，以八古祥之一的法輪作為禮致設計，令門板具有轉經輪功能的華麗裝飾。立體浮雕的法輪門板經人工精密打造，無論材質和色調皆以一貫剔透、明亮、清淨的風格。

諸佛菩薩化現於轉經輪中，帶轉經輪能消除我們一切的惡業障礙，幫助往生者化生於阿彌陀佛或觀音的淨土。



富貴 NIRVANA

欲知詳情，請聯絡您的代理
 For more information, please contact your respective agents. Nirvana Asia 富貴集團

Double : RM 41,800 - RM 63,800

Single : RM 21,800 - RM 29,800

* Price not include maintenance fees RM5,000(D) / RM2,500(S)

B2-S8

全新设计 - 法輪門板

LEVEL 2 / 2樓

富貴生命館 吉隆坡
 NIRVANA CENTER KL

Newly Launch Suite

HALL B2

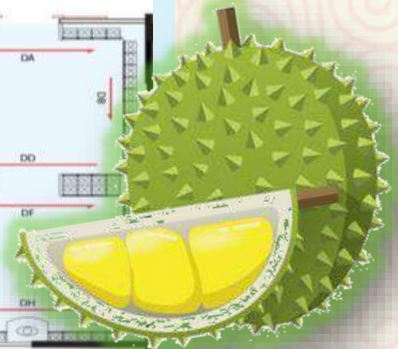

B2-S8

全新设计 - 法轮门板

1. 八吉祥之一
2. 比喻佛陀的教法, 也代表佛的手足, 表示佛常转法轮, 广度众生
3. 破厄, 运载, 圆满



Total Lot	Available Lot	%
612	518	84.64

Suite B2-S9



Double : RM 40,800 - RM 60,800
Single : RM 21,800 - RM 29,800
* Price not include maintenance fees RM5,000(D) / RM2,500(S)

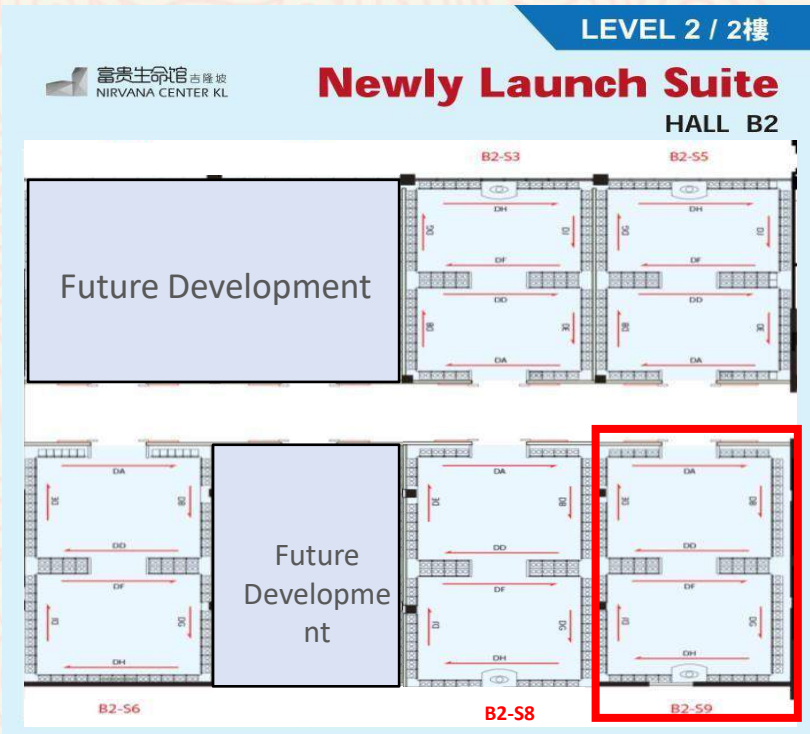



Buddha/Tao Hall D Level 2, Main Corridor

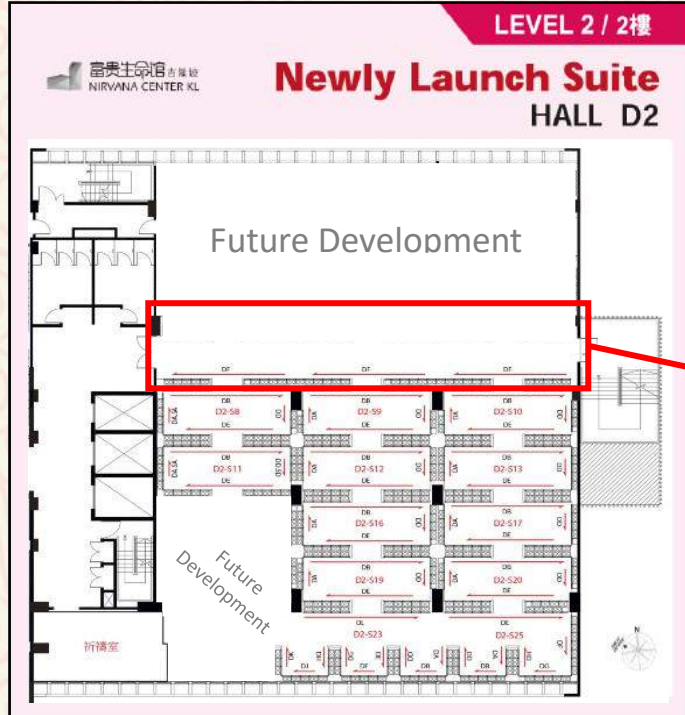

Double:

51(W) x 30(H) x 30(D)

51(W) x 36(H) x 30(D)

Single:

33(W) x 30(H) x 30(D)

33(W) x 36(H) x 30(D)

Suites D2 – S10,S13,S17,S20,S25

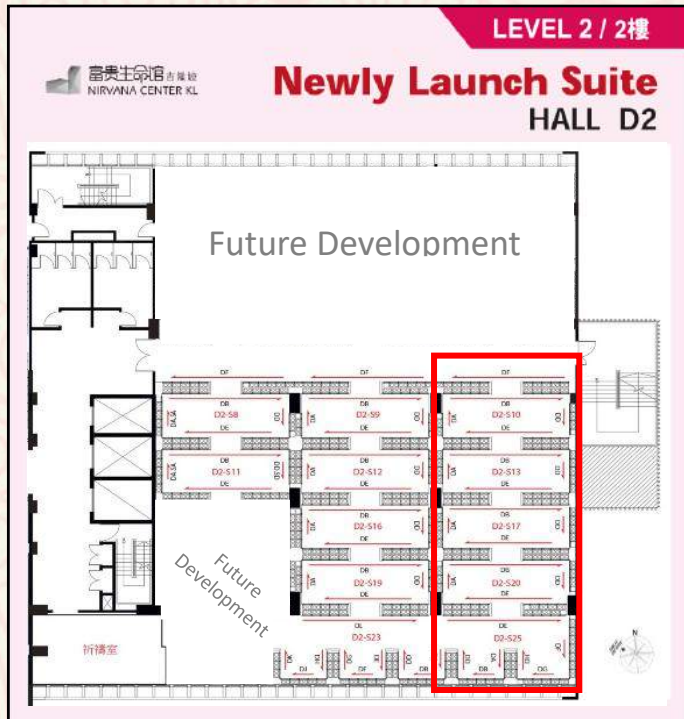



D2-S10 (Eye level / Double)
10% : RM 43,800 - RM 4,380 = RM 39,420
20% : RM 43,800 - RM 8,760 = RM 35,040
30% : RM 43,800 - RM 13,140 = RM 30,660

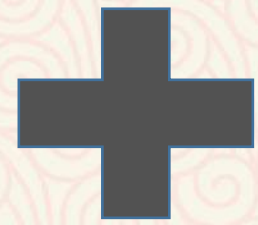

Hall D Level 3, NCKL Temporary Urn Storage





Lists of Product with GHR entitlement



Location	Zone	Lot Type
NCKL	A2-S1 (DK-DH)	Double
	A2-S1 (FJ-FG)	Twin Double
	A2-S5	Family
	B2	Double & Single
	D2	Double & Single



春节

追思礼堂
Level M2

记忆



追思礼堂 Parlour

精致化、舒适化、科技化

打造的追思礼堂

11 parlour halls named after precious gems such as Diamond, Ruby, Crystal, Amethyst, Topaz, Pearl...

Two types of laser lighting effects used in Memorial Parlour Hall which is high-end 3D stereo light engraving and 3D mapping projection on the floral wall.





春节

大堂接待处
Level G

记忆



大厅 Lobby lounge

图腾为太阳，太阳代表正能量，
如同太阳般光明亮彩。
Sun represents positive energy, bright as the sun.





V型柱子，象征着Victory。
与筷子相似，代表一家之主撑起一头家，也具有团圆之意。



V = Victory icon
Chopsticks = Master of the house support the family
and chopsticks also mean Tuan Yuan (reunion) in
Chinese culture



孔雀屏打开代表吸收正能量之意；
孔雀屏关闭代表辟邪之意。
以佛教角度来说，孔雀也寓意着吉祥。

Peacock with opened tail : Absorb the positive
energy
Peacock with closed tail : Ward off evil
Peacock also mean auspicious in Buddhism

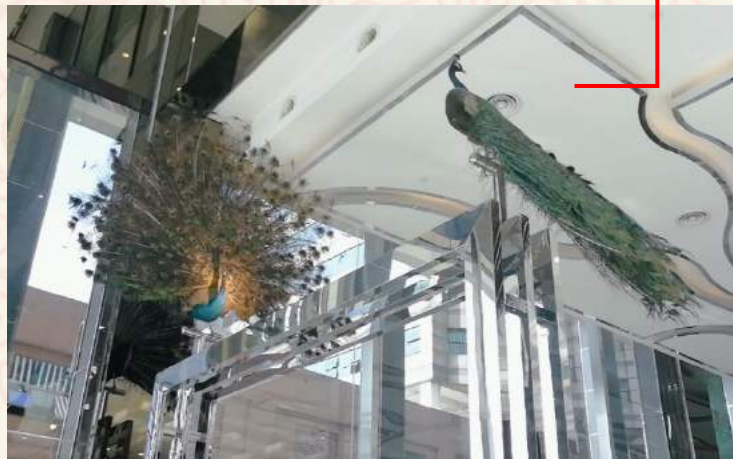

富贵生命馆优势 Unique points of NCKL

位于吉隆坡市中心黄金地段
Strategically located in a prime location

五星级设施，如花店、餐厅、
休憩大厅等
5-star facilities

融合骨灰殿堂与追思礼堂
Perfect integration of columbarium
& memorial hall

拥有超过马币一亿永久信托基金
A maintenance trust fund up To rm100 million



新年
快乐



牛
转
乾
坤